



FIRE & RESCUE



ABOUT US	4
FLOWPATH™ CONTROL	5
INNOVATIONS	6-9
FIRE FIGHTING FANS (OVERVIEW)	10-11
HOW TO CHOOSE A FAN	12-13
CONFINED SPACE RESCUE	14-19
SMOKE EJECTORS	20-21
BATTERY BLOWERS	22-27
ELECTRIC PPV BLOWERS	28-31
GAS PPV BLOWERS	32-35
WATER PPV BLOWERS	36-37
LARGE STRUCTURE VENTILATORS	38-41
PART NUMBER MODELS/ACCESSORIES	42-51
SERVICES	52

GLOBAL STRENGTH. LOCAL EXPERTISE. AT YOUR SERVICE.

Euramco Group is headquartered in San Diego, CA in the US with offices in Europe, Middle East, and Asia. We've acquired highly talented employees from around the world to lead the way in development of rotating machinery to control the flow of air to make tough job sites safer.

The world is diverse with different requirements, regulations and procedures in each region. We cater our offerings to the local market, which are guided by experts in the region providing intelligence on what is needed in their markets.

We are at your service. We offer an extended warranty on products, not because should, but because we believe in the quality of our products and stand behind them. Field service engineers are available to help discuss how our products that you purchased can be used. Competent sales engineers are ready to support via phone or email. Whether you are a first-time customer or still using our reliable products sold decades ago, we've always sought to provide the best service.

EUROPE

NORTH AMERICA

ASIA

MIDDLE EAST



FLOWPATH™ CONTROL

A fluid is anything that flows; usually a liquid or gas. And, its motion and state can be specified in terms of the velocity and pressure. Since our company's inception, we've dedicated ourselves to engineering fans and pumps to use the physics of fluid dynamics to our advantage. Whether controlling air movement through a ship's passageway at high pressure to remove heat and contaminants from below deck, or pumping water through a hose line to deliver an extinguishing agent through an industrial firefighting apparatus, the foundational physics are the same. This specialized focus on expanding the possibilities of fluid movement is at the core of our daily work, and at the core of every product we engineer. We call it FlowPath Control.







INNOVATIONS

THE FUTURE

The first and only portable fan for firefighters with hot-swappable battery packs and multi-mission capabilities. We've created mission specific kits to expand the possibilities of use. The latest software and hardware update to the IntelliSense™ controller of the EX50Li optimizes performance and makes operating the fan even easier. Additionally, the EX500/EX520 has been upgraded to include LED lights for low light operations.



TURBO BOOST

EX50Li V2



EX150Li

FASTER CHARGING



BRUSHLESS MOTORS

EX400/420



EX500/520

BATTERY TECHNOLOGY

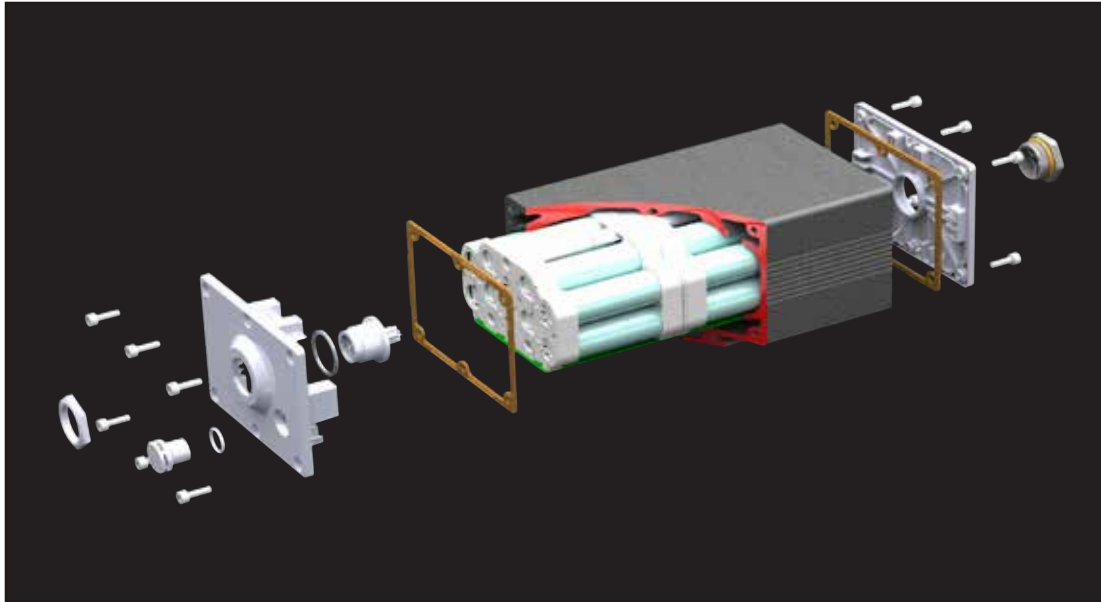

BRUSHLESS TECHNOLOGY



RAMFAN RE-WRITES THE RULES

TESTING AIRFLOW

During the ventilation process, airflow from the fan will create large amounts of entrained air. Entrained air is the natural effect from the high velocity airflow creating friction with the air next to it, thereby pulling the air into the flow path. While measuring airflow, entrained air that goes through the opening must be included in the airflow calculation to reflect realistic ventilation obtained by the fan.

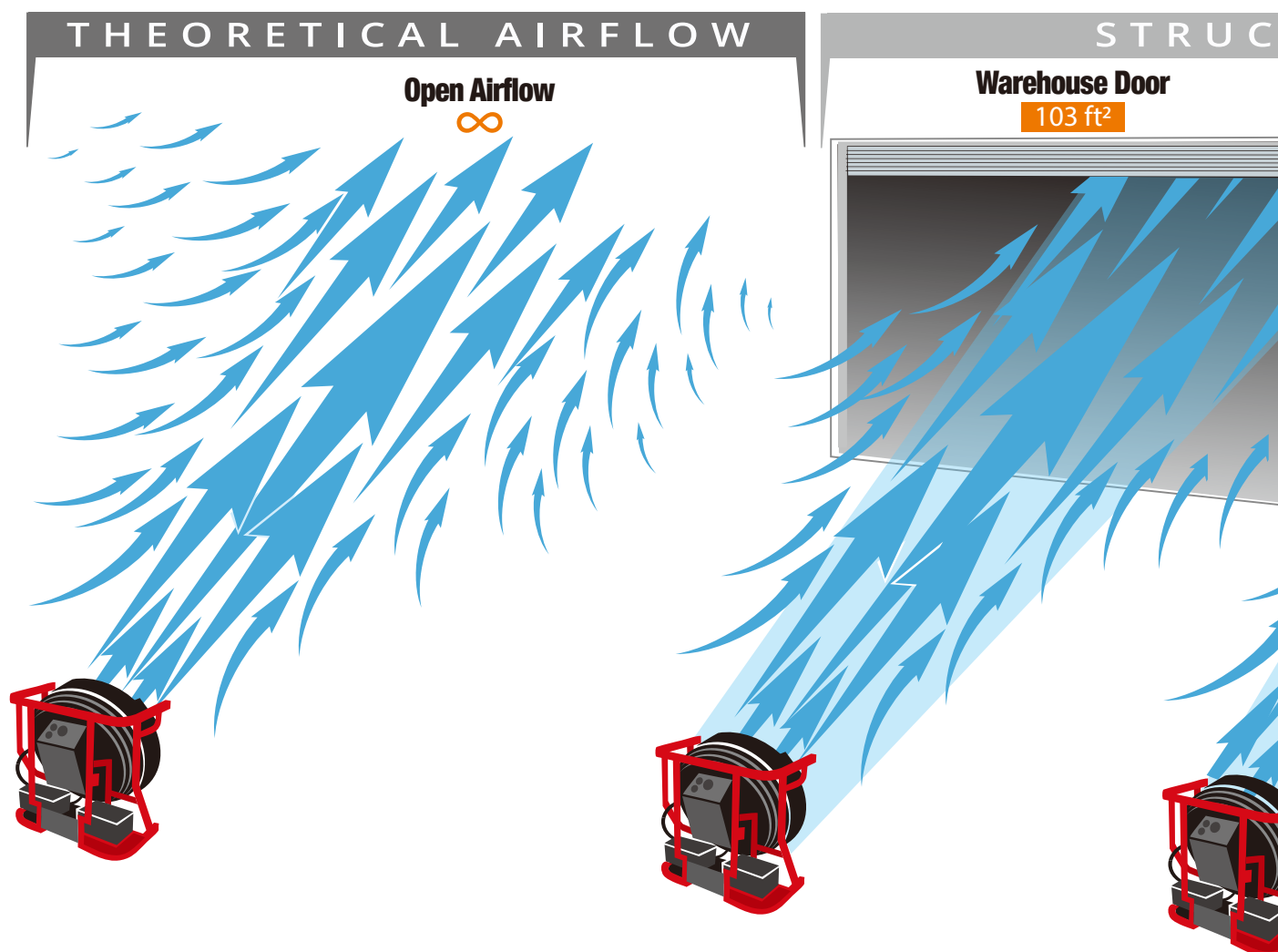
AIR INCLUDED PER MEASUREMENT METHOD

To verify airflow visit: <http://www.amca.org/certified-listed>



T U R A L A I R F L O W

Double Door

42 ft²

Single Door

AMCA 240-15
STANDARD

20 ft²

C C C F

Thru a Tube

According to
GB27901-2011
STANDARD

1.7 ft²



ENERGY POWER

Consider your mission needs.



BATTERY

Clean Atmosphere.
Quick Operation.
Best Portability.

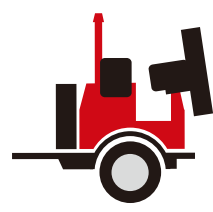

GAS

Best Performance.
Very Portable.



ELECTRIC

Clean Atmosphere.
Quick Operation.



WATER

Intrinsically Safe.
Clean Atmosphere.

AIRFLOW REQUIREMENTS

You will need a fan that is capable of ventilating structures in your response area. Airflow performance is determined by impeller design, impeller diameter and input power. We engineer each impeller for the motor its built with. For our electric fans, we even build the motors – giving us full control to meet our performance targets. We manufacture the most efficiently powerful fan impellers in the industry.

PPV AIRFLOW

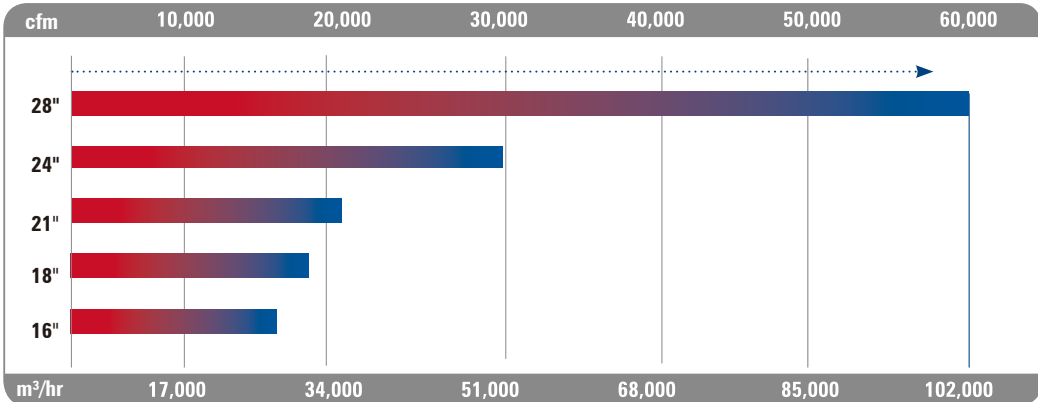

DUCTED AIRFLOW

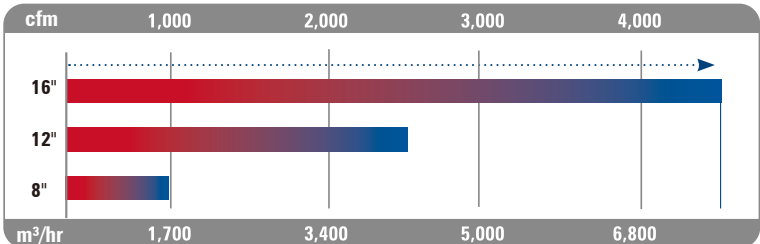

STREAM PATTERN

Shaped stream pattern can be beneficial for different missions. Straightened airflow can help to create more head, but also allows for further throw distance (i.e. fan setback from structure entrance). Fans equipped with PowerStream® air straighteners have greater positioning flexibility and a FlowPath™ that penetrates deeper through the structure than the traditional cone of air.

MAXIMUM SETBACK DISTANCE

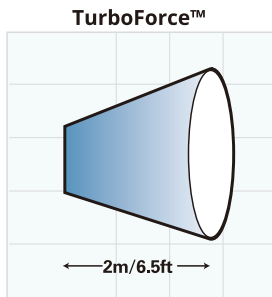

MODELS:
EF, EV, GF and WF Series

See pages 30, 34 and 37.

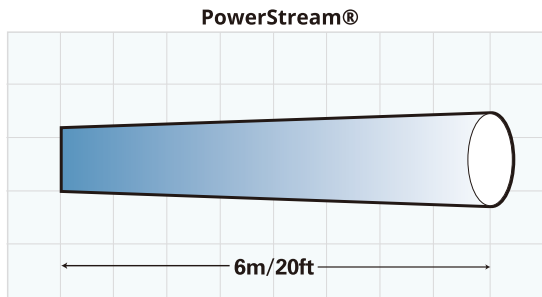

MODELS:
EX, GX, XP and VX Series

See pages 30, 34 and 40.

SIZE REQUIREMENTS

Increasing a fan's size or input power will increase the airflow. However, a large fan powered by a large motor will weigh more and take up more compartment space.

NOMINAL SIZES

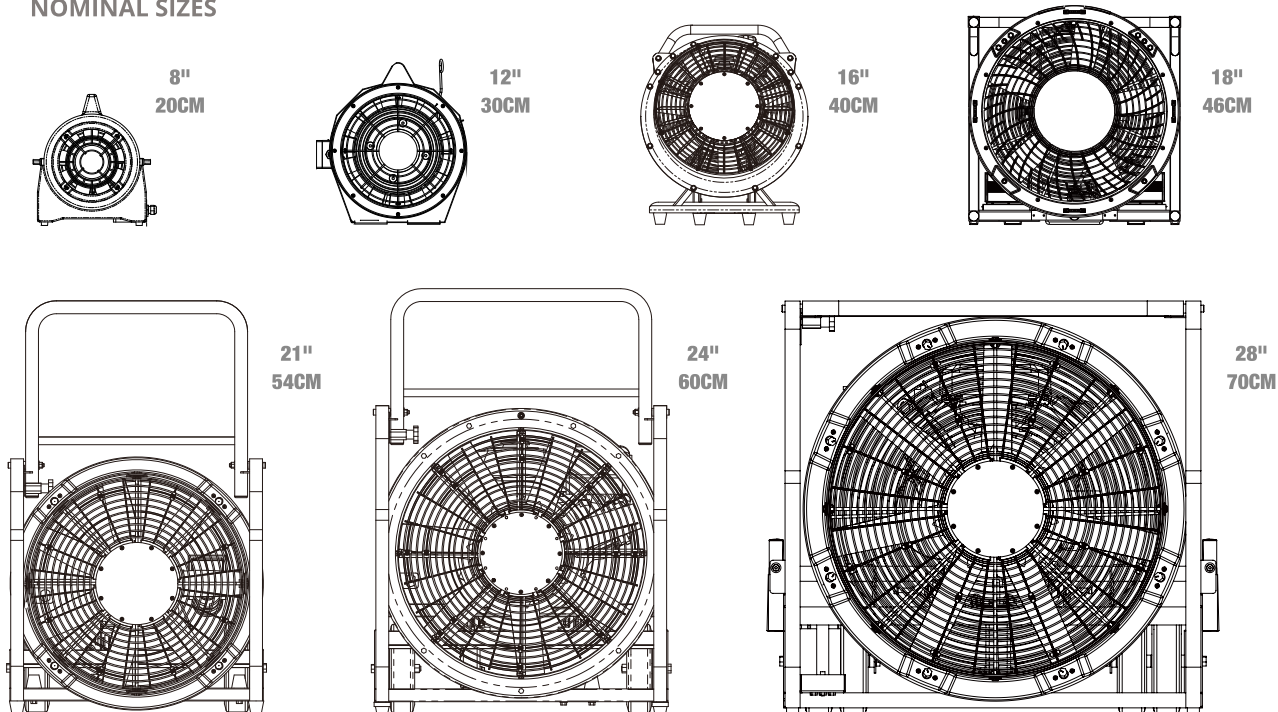



CONFINED SPACE RESCUE

EMERGENCY RESPONSE

In addition to general risks, confined space rescues require additional considerations because there is a danger of asphyxiation (lack of oxygen), poisoning, or fire and explosion. 90% of worker injuries or fatalities in confined spaces are the results of atmospheric hazards. A fan can be used during a confined space rescue to combat these risks. A fan capable of positive and negative pressure ventilation is ideal. Whole unit certified explosion-proof ventilators, such as the RAMFAN UB20xx, are the safest equipment to use in hazardous locations. They prevent a source of ignition in flammable environments.

Kits contain the required equipment for confined space rescue operations to eliminate the guesswork when placing an order. Ensure you have the ventilation equipment you need by ordering kits that contain the fan and accessories specific to your confined space rescue scenario.



M.E.D.™ Manhole Entry System In Use

UB20 M.E.D.™ MANHOLE ENTRY SYSTEM AC/DC

The M.E.D.™ allows workers to enter and exit small man-size openings while maintaining continuous ventilation. Without such a device, duct fills the manhole opening, preventing rapid entry and exit.

UB20XX M.E.D.™ MANHOLE ENTRY SYSTEM AC/DC

The explosion-proof UB20xx System utilizes high strength polymers with an anti-static housing designed to discharge static build-up safely. The M.E.D.™ allows workers to enter and exit small man-size openings while maintaining continuous ventilation.

EXTENDED DUCT SYSTEM

Quickly connect two or more RAMFAN UB20 axial blowers in series increases airflow up to 50% when blowing through long and windy duct runs. Long, windy duct runs need more power and pressure to deliver sufficient airflow, a costly proposition. The Turbo-Couple™ delivers what is needed by quickly joining two or more UB20's in series.

BATTERY PAK SYSTEM UB20 (12V DC) WITH PAK & CHARGER

RAMFAN Battery Pak with dual high-low speed control to quickly purge the area then maintain fresh air for the entire work shift. Power fan for 2.5 hours on high setting or extend up to 8 hours on low setting. Built in charger to fully recharge in 12 hours. Alternatively, the fan can be powered by a vehicle battery with supplied connectors.

UB20 IN-LINE HEATING SYSTEM

Easily connect the UB20 In-Line Heater to heat confined spaces, command centers or rescue shelters for up to 8 hours. Delivers up to 55,000 BTU of safe, warm breathable air.



UB20 M.E.D.™ MANHOLE ENTRY SYSTEM

- Order# ED7015-MED** UB20 Manhole Entry System - 115V powered blower
- Order# ED8015-MED** UB20 Manhole Entry System - 240v powered blower
- Order# ED9015-MED** UB20 Manhole Entry System - 12VDC powered blower



UB20xx M.E.D.™ MANHOLE ENTRY SYSTEM

- Order# EF7015-MEDXX** UB20XX Manhole Entry System - 115V powered blower
- Order# EF8015-MEDXX** UB20XX Manhole Entry System - 240V powered blower



BATTERY PAK SYSTEM UB20 (12V DC) PAK & CHARGER

- Order# ED9002-BAT** UB20 Battery Pack System - 12VDC battery powered blower, battery pack/charger



TWO STAGE CONVERSION

- Order# ED7300** UB20 High Pressure Turbo-Coupler



UB20 IN-LINE HEATING SYSTEM

- Order# ED7125 HT** UB20 In-Line Heater System For Tent/Shelter Heating

ACCESSORIES AVAILABLE FOR ADDITIONAL ACCESSORY INFORMATION SEE PAGES 42-51



UB20 WITH DUCT AND CANISTER



STANDARD DUCT WITH STORAGE BAG



UB20XX WITH DUCT AND CANISTER



ANTI-STATIC DUCT WITH STORAGE BAG



UB20
8"/20 cm
115V/230V/12VDC



UB30
12"/30 cm
115V/230V



SAFE

MODELS	UB20 (115V)	UB20 (230V)	UB20 (12VDC)	UB30 (115V)	UB30 (230V)
PART #	ED7002	ED8002	ED9002	EJ4002	EJ8002
MOTOR	1/3 Hp	0.19 kW	0.25 Hp/0.19 kW	1 Hp/0.75 kW	
ELECTRIC	115V, 50/60Hz, 1Ø	230V, 50/60Hz, 1Ø	12VDC	115V, 50/60Hz, 1Ø	230V, 50/60Hz, 1Ø
WEIGHT	17 lbs/8 kg			37 lbs/17 kg	
DIMENSIONS (h/w/d)	14/12/13 in 36/31/33 cm			20/15.5/12 in 51/39/31 cm	
AIRFLOW					
FREE AIR	980 cfm 1,666 m ³ /hr	819 cfm 1,392 m ³ /hr	862 cfm 1,465 m ³ /hr	2,420 cfm 4,114 m ³ /hr	2,017 cfm 3,429 m ³ /hr
Through Duct:					
15'/4.6 m w/ one 90° turn:	789 cfm 1,341 m ³ /hr	659 cfm 1,120 m ³ /hr	695 cfm 1,181 m ³ /hr	2,050 cfm 3,485 m ³ /hr	1,500 cfm 2,550 m ³ /hr
15'/4.6 m w/ two 90° turns:	666 cfm 1,132 m ³ /hr	558 cfm 948 m ³ /hr	586 cfm 996 m ³ /hr	1,875 cfm 3,188 m ³ /hr	1,376 cfm 2,340 m ³ /hr
25'/7.6 m w/ one 90° turn:	722 cfm 1,227 m ³ /hr	603 cfm 1,025 m ³ /hr	635 cfm 1,079 m ³ /hr	1,825 cfm 3,103 m ³ /hr	1,400 cfm 2,380 m ³ /hr
25'/7.6 m w/ two 90° turns:	614 cfm 1,044 m ³ /hr	510 cfm 867 m ³ /hr	537 cfm 912 m ³ /hr	1,750 cfm 2,975 m ³ /hr	1,324 cfm 2,250 m ³ /hr

ACCESSORIES AVAILABLE FOR ADDITIONAL ACCESSORY INFORMATION SEE PAGES 42-51



**STANDARD DUCT
WITH BAG**



**QUICK COUPLE™
CANISTER**



UB20xx
8"/20 cm
115V/230V

EFi75xx
12"/30 cm
115V/230V

SAFEST				
MODELS	UB20xx (115V)	UB20xx (230V)	EFi75xx (115V)	EFi75xx (230V)
PART #	EF7002	EF8002	EB7201XX	EB7201XX-230
MOTOR	1/3 Hp	0.19 kW	0.75 Hp	0.56 kW
ELECTRIC	115V, 50/60Hz, 1ø	230V, 50/60Hz, 1ø	115V, 50/60Hz, 1ø	230V, 50/60Hz, 1ø
WEIGHT	27 lbs/12 kg		44 lbs/20 kg	
DIMENSIONS (h/w/d)	14/14/15.5 in 35/35/39 cm		16/15/16 in 41/38/41 cm	
AIRFLOW				
FREE AIR	980 cfm 1,666 m³/hr	819 cfm 1,392 m³/hr	2,500 cfm 4,250 m³/hr	
Through Duct:				
15'/4.6 m w/ one 90° turn:	789 cfm 1,341 m³/hr	659 cfm 1,120 m³/hr	1,664 cfm 2,829 m³/hr	
15'/4.6 m w/ two 90° turns:	666 cfm 1,132 m³/hr	558 cfm 948 m³/hr	1,529 cfm 2,599 m³/hr	
25'/7.6 m w/ one 90° turn:	722 cfm 1,227 m³/hr	603 cfm 1,025 m³/hr		
25'/7.6 m w/ two 90° turns:	614 cfm 1,044 m³/hr	510 cfm 867 m³/hr		

ACCESSORIES AVAILABLE FOR ADDITIONAL ACCESSORY INFORMATION SEE PAGES 42-51



ANTI-STATIC DUCT
WITH BAG



QUICK COUPLE™
CANISTER



SMOKE EJECTORS

BLOWER/EXHAUSTER

Smoke Ejectors are used to extract smoke from a structure using negative pressure. They can be hung from a door bar while exhausting smoke out a door or window and they can be connected to duct to direct air to a specific location. Choose between general use "safe" smoke ejectors, a "Safer" version with an explosion proof motor, or "safest" smoke ejectors that are whole-unit certified explosion-proof for use in hazardous locations.



EFC50x/EFC120x/EFC150x

SAFE

Heat-resistant Lexan® housing



EFC50/EFC120/EFC150

SAFER

Heat-resistant Lexan® housing & explosion proof motors



EFI50xx/EFI120xx/EFI150xx

GAS
ZONES
1•2

SAFEST

Certified Explosion Proof Ventilators



SAFE					
MODELS	EFC50 (115V/230V)		EFC120 (230V)	EFC150 (115V/230V)	
PART#	EA7000	EA7000-230	EA7300	EG8000	EG8000-230
WEIGHT	49 lbs/22 kg		49 lbs/22 kg	55 lbs/25 kg	
DIMENSIONS (h/w/d)	19/18/12 in 48/46/31 cm		19/18/16 in 48/46/41 cm	19/18/12 in 48/46/31 cm	
POWER	0.5 Hp/0.37 kW		1.2 Hp/0.9 kW	1.5 Hp/1.1 kW	
ELECTRIC	115V, 1ø, 50/60Hz	230V, 1ø, 50/60Hz	230V, 1ø, 50Hz	115V, 1ø, 50/60Hz	230V, 1ø, 50/60Hz
DUCT ADAPTERS	0		2	0	
AIRFLOW	EFC50		EFC120	EFC150	
FREE AIR	3,200 cfm		3,750 cfm	4,459 cfm	
THROUGH DUCT	5,440 m³/hr		6,375 m³/hr	7,580 m³/hr	
15'/4.6 m w/ one 90° turn:	1,935 cfm 3,289 m³/hr		2,700 cfm 4,590 m³/hr	3,179 cfm 5,404 m³/hr	

SAFER					
MODELS	EFC50x (115V/230V)		EFC120x (230V)	EFC150x (115V/230V)	
PART#	EA7000X	EA7000X-230	EA7300X	EG8000X	EG8000X-230
WEIGHT	49 lbs/22 kg		53 lbs/24 kg	55 lbs/25 kg	
DIMENSIONS (h/w/d)	19/18/12 in 48/46/31 cm		19/18/16 in 48/46/41 cm	19/18/16 in 48/46/31 cm	
POWER	0.5 Hp/0.37 kW		1.2 Hp/0.9 kW	1.5 Hp/1.1 kW	
ELECTRIC	115V,1ø, 50/60Hz	230V,1ø, 50/60Hz	230V, 1ø, 50Hz	115V,1ø, 50/60Hz	230V,1ø, 50/60Hz
DUCT ADAPTERS	0		2	2	
AIRFLOW	EFC50x		EFC120x	EFC150x	
FREE AIR	3,200 cfm		3,750 cfm	4,459 cfm	
THROUGH DUCT	5,440 m³/hr		6,375 m³/hr	7,580 m³/hr	
15'/4.6 m w/ one 90° turn:	1,935 cfm 3,289 m³/hr		2,700 cfm 4,590 m³/hr	3,179 cfm 5,404 m³/hr	

SAFEST						
MODELS	EFi50xx (115V/230V)		EFi120xx (110V/240V)		EFi150xx (115V/230V)	
PART#	EA8000XX	EA8000XX-230	EA8120XX-110	EA8120XX	EG8200XX	EG8200XX-230
WEIGHT	49 lb/22 kg		55 lbs/25 kg		61 lbs/28 kg	
DIMENSIONS (h/w/d)	19/18/16 in 48/46/41 cm		19/18/16 in 48/46/41 cm		19/18/16 in 48/46/41 cm	
POWER	0.5 Hp/0.37 kW		1.2 Hp/0.9 kW		1.5 Hp/1.1 kW	
ELECTRIC	115V, 1ø, 50/60Hz	230V, 1ø, 50/60Hz	110V, 1ø, 50Hz	240V, 1ø, 50Hz	115V, 1ø, 50/60Hz	230V, 1ø, 50/60Hz
DUCT ADAPTERS	2		2		2	
AIRFLOW	EFi50xx		EFi120xx		EFi150xx	
FREE AIR	3,200 cfm		3,750 cfm		4,459 cfm	
THROUGH DUCT	5,440 m³/hr		6,375 m³/hr		7,580 m³/hr	
15'/4.6 m w/ one 90° turn:	1,935 cfm 3,289 m³/hr		2,700 cfm 4,590 m³/hr		3,179 cfm 5,404 m³/hr	

ACCESSORIES AVAILABLE FOR ADDITIONAL ACCESSORY INFORMATION SEE PAGES 42-51



**TILT
BRACKET**



**DUCT
ADAPTER**



**DOOR BAR HANGER
AND KIT**



**MULTI PURPOSE
ACCESSORY KIT**



**ANTI-STATIC DUCT WITH
STORAGE BAG**



**STANDARD DUCT WITH
STORAGE BAG**



BATTERY BLOWERS

MULTI MISSION FAN AND KITS

The most versatile battery fans available. The EX50Li and EX150Li can be used in a variety of firefighting and rescue scenarios with kits designed to include all you will need to accomplish your mission. How-swappable 40V and 52V Lithium-Ion battery packs can be replaced during operation to keep the flow path going during extended operations. The EX50Li and EX150Li with swappable battery packs ensure your equipment is always ready with zero downtime.

EX150Li & EX50Li MISSION KITS

The battery powered fan and accessories are organized into logical packages to accomplish specific missions. We've created kits that contain everything required to safely conduct missions for a wide range of scenarios.

FEATURES

MULTI-MISSION

The fan can be used in a variety of ways with several kits and accessories available to accomplish your mission.

HOT-SWAPPABLE BATTERIES

Keep the FlowPath™ going! Don't get stuck with a dead fan or scrambling for an outlet

INTELLISENSE™ E2 CONTROLLER

Next generation controller

BRUSHLESS MOTOR

Advanced BLDC motor by Euramco Safety has longer motor life and longer run-time

ADVANCED FLOWPATH™

Control 0-35° tilt with 5 way positioning to create the ideal unobstructed FlowPath thru a structure

2ND GENERATION POWERSTREAM®

Air straighteners for further fan setback or deeper

penetration through a structure

OPTIONAL EXTERNAL CHARGER

Mounted in a fire apparatus or at the fire department to rapidly charge two RAMFAN 40V batteries at the same time.

OPTIONAL INTEGRATED MISTERS

Used for firefighter rehabilitation

IP66 WATER RESISTANT

IP66 rated motor, controller and battery pack

SCENE LIGHTING

Light up the night with LED lights standard

DUAL POWER

Seamlessly switch between AC or DC Power

LIGHTWEIGHT

Aircraft grade aluminum alloy frame is light and durable

ZERO-DOWNTIME PACKAGE

Includes RAMFAN EX50Li (1), carrying strap for fan (1), Hot-Swappable 40V 6Ah battery packs (4) that can be replaced in under 30 seconds while the fan is running! An external battery charger (1) that will simultaneously charge two battery packs and a custom truck compartment mount (1) that snugly wraps around the EX50Li to secure fan in the truck compartment.

ZERO-DOWNTIME COMPLETION KIT

Already own an EX50Li with 2 battery packs? Upgrade to the Zero Downtime Package with battery packs (2), an external battery charger (1), and truck compartment mount (1).

SMOKE EJECTOR SUPPLEMENTAL KIT

Throw away your old box fans. Includes door bar (1) and hanger straps (2).

CONFINED SPACE RESCUE SUPPLEMENTAL KIT

High flow confined space venting. Includes duct adapter/reducer (1), 16"/40cm standard duct 15'/4.6m length (1), and duct carrying bag (1).

2-PACK KIT

Just the basics. Includes RAMFAN EX50Li, 40V 6Ah battery packs (2) and carrying strap (1).

REHABILITATION SUPPLEMENTAL KIT

Recover quicker. Includes factory installed, integrated misters.

WHEEL KIT

Smooth-rolling, never-flat tires with a durable, retractable handle. Includes factory installed telescopic handle with wheels.



ZERO DOWNTIME PACKAGE

ACCESSORIES AVAILABLE FOR ADDITIONAL ACCESSORY INFORMATION SEE PAGES 42-51

E150Li



52V LI-ION BATTERY PACK
MI-52V



EXTERNAL BATTERY CHARGER
M1C-6500

EX50Li



40V LI-ION BATTERY PACK
R2-360-AHU



EXTERNAL BATTERY CHARGER
RSC-5500



FOAM GENERATOR
HI-5000

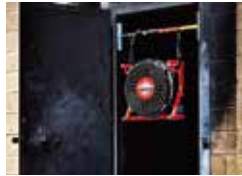

DOOR BAR AND HANGER KIT
EL7095K

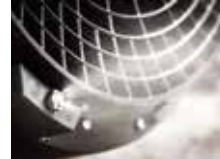

INTEGRATED MISTERS
EL8111



FLEXIBLE DUCT
FDT-185MSR / 1810MSR



VEHICLE MOUNT KIT
EL600K-EL610K



WHEEL KIT
EL6015



18"/46 cm

MAXIMUM SETBACK DISTANCE

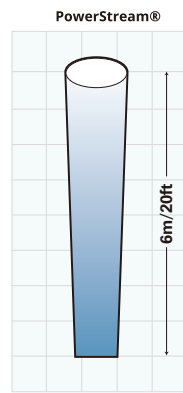

FAN CATEGORY COMPARISON

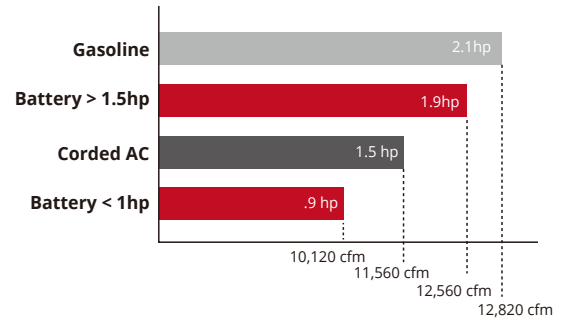

SMOKE EJECTOR



ZERO DOWNTIME



CONFINED SPACE



REHABILITATION

EX50Li & EX150Li (battery powered)

The latest technology integrated into this all-purpose ventilator with swappable batteries. Use for PPV, Smoke Ejector, Confined Space or Rehabilitation. Starts instantly on battery power and lasts 45 minutes on max speed or hours on low speed to keep air moving. Integrated LED lights for night ops. Built with aircraft grade, lightweight aluminum frame.

STAY UNPLUGGED, INDEFINITELY!

Swappable battery packs with enhanced IP66 water jet protection to protect against the inevitable sweep of the fire hose. The ability to have extra packs ready to go removes the limitations of other battery fan concepts, leading towards full corded fan replacement on the fire ground.

40V & 52V LITHIUM ION BATTERY PACKS ADVANCED



High Energy Density Lithium Ion battery system was designed specifically for the high draw and sustained run-time applications demanded of PPV fans.



PPV

Equipped with 2nd generation PowerStream® airflow straighteners for flexible positioning, reduced noise inside the structure and a deeper FlowPath™ through the structure.

SMOKE EJECTION

Perfectly balanced to hang from a doorbar during smoke ejection.

SPECIFICATIONS		Motor	Runtime @ Max. Speed	Battery System (2 Battery Packs)	IP Rating	Dimensions (h x w x d)	Weight
Model	Order#						
EX50Li	EL5500	0.8 HP/ 0.6 kW	DC: 90 minutes (four battery packs)	40V Lithium-Ion, 432 Wh, 12 Ah	IP66 / IP66 / IP66	22" x 21" x 12" in / 56 x 53 x 30 cm	with two batteries: 54 lbs / 25 kg without batteries: 45 lbs / 20 kg
	EL5500-230		DC: 45 minutes (two battery packs) DC: 23 minutes (one battery pack) AC: Unlimited				
NSN (Nato Stock Number) 4140-01-667-0430							
Approvals :  							
AMCA Verified Airflow DC Power Supply : 10,120 cfm (17,194 m³/hr) AC Power Supply : 9,635 cfm (16,370 m³/hr)							

SPECIFICATIONS		Motor	Runtime @ Max. Speed	Input AC	Battery System	IP Rating	Dimensions (h x w x d)	Weight
Model	Order#							
EX150Li	EL6500 2PK	1.9hp / 1.4kw	DC:45 min DC Max: 30 min AC: Unlimited	Multiple plug options available	52V Lithium-Ion, 832Wh, 16Ah	IP66 / IP66 / IP66	23 x 21 x 19 in / 58 x 53 x 48 cm	with two batteries: 71 lbs / 32 kg without batteries: 58 lbs / 26 kg
Approvals :  								
AMCA Verified Airflow DC Power Supply : 12,377 cfm (21,029 m³/hr) AC Power Supply : 11,896 cfm (20,211 m³/hr)								



ELECTRIC PPV BLOWERS

CLEAN ATMOSPHERE & QUICK OPERATION

Electric fans do not emit carbon monoxide which makes them an attractive option for ventilating smaller structures. Most electric fans on the market will top off around 1.5 Hp/ 1.1 kW because the limitation of current that can be drawn from an outlet without tripping the breaker.



EF390H
16"/40 cm



EV400/EV420
16"/40 cm

**MAXIMUM SETBACK
DISTANCE**

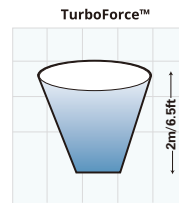

EX400/EX420
16"/40 cm



EX500/EX520
18"/46 cm

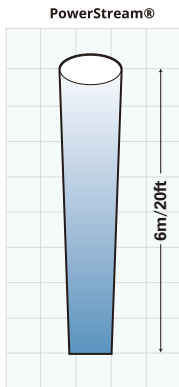

XP400/XP420
16"/40 cm



XP500/XP520
18"/46 cm

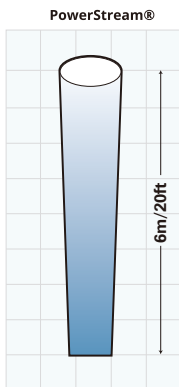

EF SERIES

Powerful Single-Speed electric PPV fan.

EV SERIES

Electric PPV fans with IntelliSense™ water-resistant, variable speed controls deliver continuous airflow adjustment from zero to maximum speed.

EX SERIES

The latest electrical variable speed fans equipped with IntelliSense™ and patented PowerStream® air straighteners for greater flow velocities and flexible setback.

XP SERIES

Equipped with PowerStream® air straighteners. ATEX Certified motor to safely purge hazardous gases.

SPECIFICATIONS		Single Door Airflow	Motor	Power	Weight	Dimensions (h/w/d)
Models	Order#					
EF390H	EA5403	11,765 cfm 20,001 m³/hr	2.2 Hp/ 1.7 kW	230V, 1Ø, 50Hz, 12A	78 lbs 35 kg	23/17.5/18.5 in 58/44/47 cm
EV400	EB80500	11,391 cfm 19,365 m³/hr	1.5 Hp/ 1.1 kW	115V, 1Φ, 60Hz, 15A or 20A	68 lbs 31 kg	22.6/17.4/18.5 in 57/44/47 cm
EV420	EB80510	10,994 cfm 18,690 m³/hr	1.5 Hp/ 1.1 kW	230V, 1Φ, 60Hz, 10A	68 lbs 31 kg	22.6/17.4/18.5 in 57/44/47 cm
	EB81505 (CE)	10,994 cfm 18,690 m³/hr	1.5 Hp/ 1.1 kW	230V, 1Φ, 50Hz, 10A	68 lbs 31 kg	22.6/17.4/18.5 in 57/44/47 cm
EX400	EB80600	11,391 cfm 19,365 m³/hr	1.5 Hp/ 1.1 kW	115V, 1Φ, 60Hz, 15A or 20A	68 lbs 31 kg	22.6/17.4/18.5 in 57/44/47 cm
EX420	EB88245	10,994 cfm 18,690 m³/hr	1.5 Hp/ 1.1 kW	230V, 1Φ, 50/60Hz, 10A	68 lbs 31 kg	22.6/17.4/18.5 in 57/44/47 cm
EX500	EK86500	11,540 cfm 19,618 m³/hr	1.5 Hp/ 1.1 kW	115V, 1Φ, 60Hz, 15A or 20A	70 lbs 32 kg	23.5/21/18.5 in 60/ 53/ 47 cm
EX520	EK86520	13,354 cfm 22,702 m³/hr	1.5 Hp/ 1.1 kW	230V, 1Φ, 50/60Hz, 10A	70 lbs 32 kg	23.5/21/18.5 in 60/53/47 cm
XP400	EB80500X	11,391 cfm 19,365 m³/hr	1.5 Hp/ 1.1 kW	115V, 1Φ, 50/60Hz, 15A	68 lbs 31 kg	22.6/17.4/18.5 in 57/44/47 cm
XP420	EB80500X-230	10,994 cfm 18,690 m³/hr	1.5 Hp/ 1.1 kW	230V, 1Φ, 50/60Hz, 8A	68 lbs 31 kg	22.6/17.4/18.5 in 57/44/47 cm
XP500	EB90600X	10,589 cfm 18,001 m³/hr	1.5 Hp/ 1.1 kW	115V, 1Φ, 50/60Hz, 15A	72 lbs 33 kg	23.5/21/18.5 in 60 /53 /47 cm
XP520	EB90600X-230	8,824 cfm 15,001 m³/hr	1.5 Hp/ 1.1 kW	230V, 1Φ, 50/60Hz, 8A	72 lbs 33 kg	23.5/21/18.5 in 60/53/47 cm

ACCESSORIES AVAILABLE FOR ADDITIONAL ACCESSORY INFORMATION SEE PAGES 42-51



INTEGRATED MISTING SYSTEM



18"/46 CM DUCT ADAPTER/REDUCER



LAYFLAT DUCT



STANDARD DUCT WITH STORAGE BAG



DISPOSABLE DUCT



A close-up photograph of a gas-powered blower. The image shows a black metal protective cage with curved bars. In the lower-left corner, a portion of a red fan blade with white curved patterns is visible. The background is a bright, overexposed white area.

GAS PPV BLOWERS

BEST PERFORMANCE

Gas is still the most energy dense fuel available. Gasoline powered fans used in PPV produce higher airflow rates than electric fans of the same nominal size. From the very low CO output to the 2hp GX200L to the ultra-durable Honda 5.5hp that's been known to last decades, these fans will out blow any fan you set it next to.



GX200L
16"/40 cm
36 lbs /16 kg



GX200
16"/40 cm
48 lbs /22 kg

MAXIMUM SETBACK DISTANCE

PowerStream®

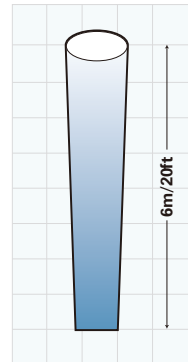

GX310/GX350
18"/46 cm



GX400
21"/54 cm

PowerStream®

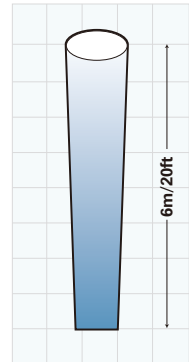

GF164SE
16"/40 cm



GF165
16"/40 cm



GF210
21"/54 cm

TurboForce™

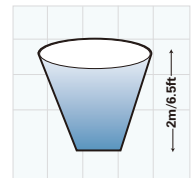

ULTRA LIGHTWEIGHT SERIES

RAMFAN offers the lightest PPV fans on the market, providing the ultimate portability.

GX SERIES

High performance PPV fans for structural firefighting. The GX Series blowers are equipped with PowerStream® air straighteners that tighten the airflow to keep it focused over longer distances without losing significant power; permitting unrestricted setback from the access point, reduced interference with communication and flexible positioning. The PowerStream FlowPath™ penetrates deeper through the structure than a traditional cone of air.

GF SERIES

Tried and true, the GF series have been around since RAMFAN got its start. The economical gas fans are well known for their durability.

SPECIFICATIONS		Single Door Airflow	Double Door Airflow	Engine	Weight	Dimensions (h/w/d)
Models	Order#					
GX200L	GG5500	12,820 cfm 21,794 m³/hr		Honda GXH50 2.1 Hp/1.6 kW	36 lbs 16 kg	22/18.5/20 in 56/47/51 cm
GX200	GG5010	12,820 cfm 21,794 m³/hr		Honda GXH50 2.1 Hp/1.6 kW	48 lbs 22 kg	21.5/19.5/20.5 in 55/50/52 cm
GF164SE	GB5001HSE	11,653 cfm 19,810 m³/hr		Honda GC160 4.6 Hp/3.4 kW	59 lbs 27 kg	21/20/17 in 53/51/43 cm
GF165	GA5006	12,906 cfm 21,940 m³/hr		Honda GX160 4.8 Hp/3.5 kW	84 lbs 38 kg	22/20.2/20 in 56/51/51 cm
GX310	GH5010	16,968 cfm 28,846 m³/hr		Honda GX160 4.8 Hp/3.5 kW	82 lbs 37 kg	21.6/21.7/19.6 in 55/55/50 cm
GX350	GH5005	18,705 cfm 31,799 m³/hr		Honda GX200 5.5 Hp/4.1 kW	84 lbs 38 kg	21.6/21.7/19.6 in 55/55/50 cm
GF210	GE5001	16,797 cfm 28,555 m³/hr	22,500 cfm 38,250 m³/hr	Honda GX160 4.8 Hp/3.5 kW	88 lbs 40 kg	24.8/25.3/22.4 in 63/64.3/22.4 cm
GX400	GE5022	16,797 cfm 28,555 m³/hr	22,500 cfm 38,250 m³/hr	Honda GX200 5.5 Hp/4.1 kW	88 lbs 40 kg	24.9/25/22 in 63/64/56 cm
	GE5010			Vanguard 13L332 6.5 Hp/4.8 kW	94 lbs 43 kg	

ACCESSORIES AVAILABLE FOR ADDITIONAL ACCESSORY INFORMATION SEE PAGES 42-51



BIGBORE™ EXHAUST DIVERTER



MULTI-PURPOSE ACCESSORY KIT



INTEGRATED MISTING SYSTEM



18''/46 CM DUCT ADAPTER/REDUCER



COOLING COLLARS/MISTERS



EXHAUST DIVERTER HOSE



STANDARD DUCT WITH BAG



HOUR METER

WATER PPV BLOWERS

BLOWER/EXHAUSTER

Safer... RAMFAN's water powered design minimizes risk in hazardous environments. More Efficient.. RAMFAN's patented Axial Flow Turbine Technology leads the way in converting water power into high velocity airflow more efficiently than any water fan on the market today. Better... RAMFAN's axial turbine is built of corrosion-proof composite materials for long life, simple maintenance and easy replacement of parts.



WF SERIES

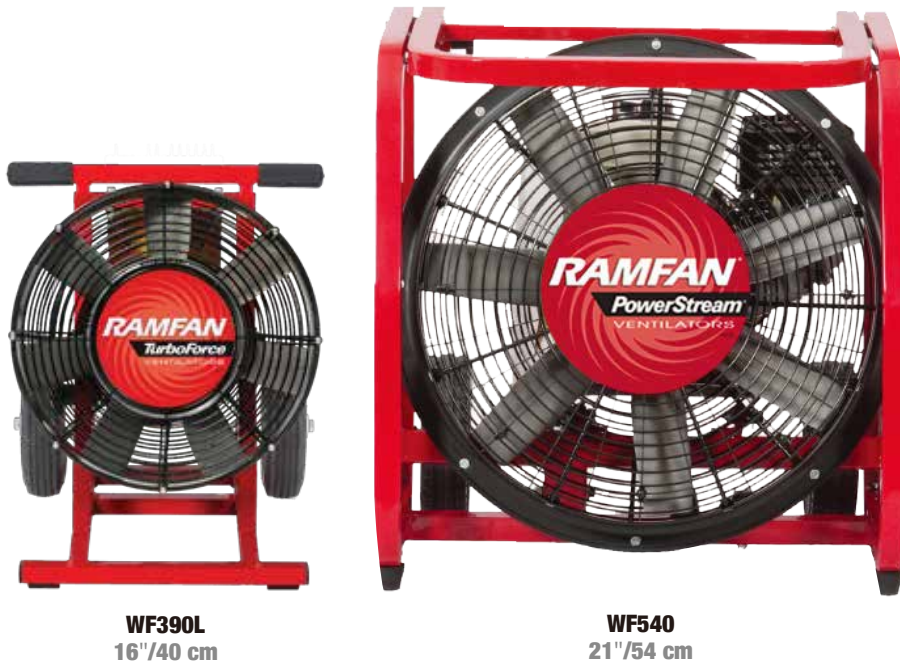

MAXIMUM SETBACK DISTANCE

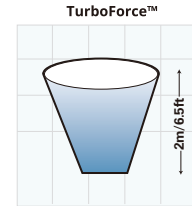

SPECIFICATIONS		Single Door Airflow	Nominal Pressure	Max Pressure	Dimensions (h/w/d)	Weight
Models	Order#					
WF390L	WB5001LB	17,417 cfm 29,610 m³/hr	150psi /1.0MPa	250psi/1.7MPa	22.8/16.9/16 in 58/43/41 cm	60 lbs 27 kg
	WB5001LNH					
WF540	WD5010	22,443 cfm 38,154 m³/hr	150psi /1.0MPa	250psi/1.7MPa	25.6/24.8/20.9 in 65/ 63/53 cm	75 lbs 34 kg

Models	Order#	Upgrade
WF390L	GA400K	Powerstream
WF540	GE400K	Powerstream

ACCESSORIES AVAILABLE FOR ADDITIONAL ACCESSORY INFORMATION SEE PAGES 42-51



INTEGRATED MISTING SYSTEM

LARGE STRUCTURE VENTILATORS

MASSIVE AIRFLOW

Big fans for big buildings large volumes of high-velocity airflow is required for ventilating large and complex structures. Quickly removing smoke, gases, engine exhaust or particulates from a large confined area increases safety of both personnel and property, reducing the chances of toxic inhalation and general atmospheric danger.



LSV = LARGE STRUCTURE VENTILATORS =

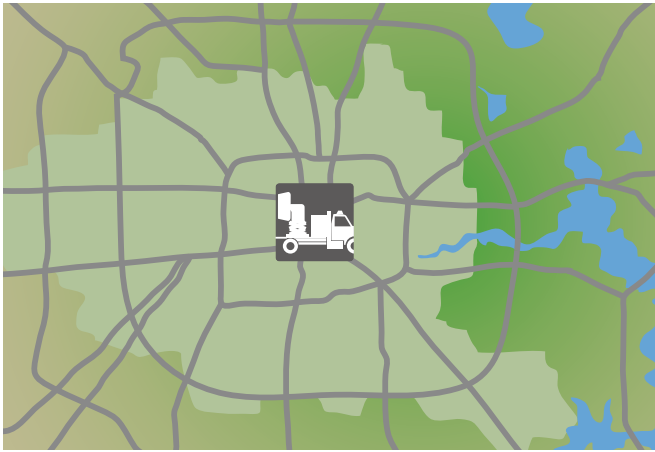

COME OF AGE AS ONLINE COMMERCE GROWS

Online retailing today is filling warehouses everywhere with products. Adding these to the current inventory of big box stores, airports, high-rises and hotels, the need for tools to fight large structure fires is clear.

These large structures require massive PPV ventilation because you can't support fire fighting operations in a large structure with small structure equipment.

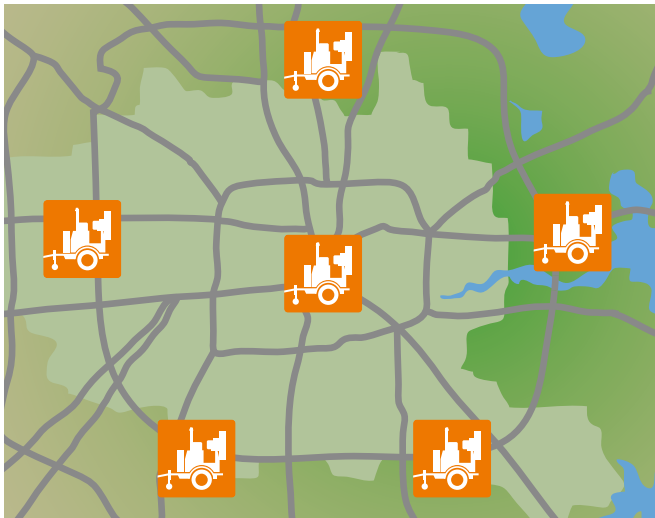

ONE HUGE FAN DOESN'T MAKE SENSE ANYMORE

Until now, Large Structure Ventilators have been huge monsters that are difficult to move and maneuver, which can limit access to the structure on fire. They require a large storage space and have price tags that are budget-busters. This limits most cities to a single unit for the entire area.

RAMFAN LSV's are the solution to these problems. The largest LSV is a 28" trailer mounted fan that is small enough for one person to maneuver but powerful enough to quickly pressurize a high-rise stairwell and is offered at a price point so low you can buy 6 LSV's for every one truck mounted fan.

WHEN IT COMES TO EQUIPMENT ACCESS WHICH WOULD YOU PREFER: A SINGLE HUB OR A DISTRIBUTED NETWORK?

If your city owns one large truck mounted fan stored in a central location and you respond to a warehouse fire on the outskirts of the city the response time may be too long to get the equipment to the scene. But if you had a distributed network of large fans it would cut the response time in less than half.

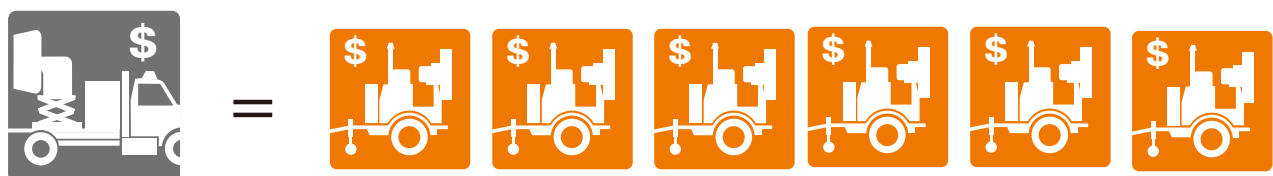



GX500
24"/60 cm



GX600
28"/70 cm

**MAXIMUM SETBACK
DISTANCE**

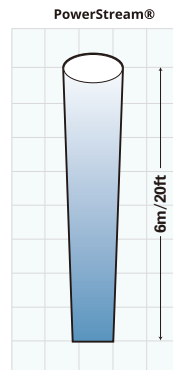

VX700
28"/70 cm

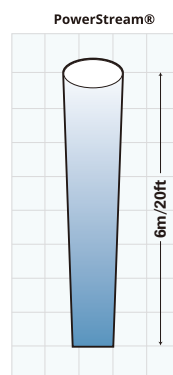



VX700 SKID MOUNTED
28"/70 cm



VARIATIONS

EUROPEAN TRAILER MOUNTED



CONTINUOUS TRACK MOUNTED

SPECIFICATIONS		Double Door Airflow	Warehouse Door	Engine	Weight	Dimensions (h/w/d)
Models	Order#					
GX500	GD5005	27,800 cfm 47,260 m³/hr	37,700 cfm 64,090 m³/hr	Honda GX270 8.5 Hp/6.3 kW	137 lbs 62 kg	30/29/26.7 in 76/74/68 cm
GX600	GJ5005	32,500 cfm 55,250 m³/hr	49,000 cfm 83,300 m³/hr	Vanguard V-Twin OHV mod. 35 18 Hp/13.4 kW	175 lbs 80 kg	34.5/37.3/30.3 in 88/95/77 cm
VX700	GK5000 Skid Mounted	46,700 cfm 79,390 m³/hr	60,200 cfm 105,400 m³/hr	Honda GX630 20.8 Hp/15.5 kW	220 lbs 100 kg	49/33.3/47.3 in 124/85/120 cm
	GK5005 US Trailer				920 lbs 417 kg	6.6/4.8/10.3 ft 2/1.4/3.1 m
	GK5010 Euro Trailer					6.7/5/10.5 ft 2/1.5/ 3.2 m

ACCESSORIES AVAILABLE FOR ADDITIONAL ACCESSORY INFORMATION SEE PAGES 42-51



BIGBORE™ EXHAUST DIVERTER



EXHAUST DIVERTER HOSE



INTEGRATED MISTING SYSTEM



HOUR METER



PART NUMBER MODELS/ ACCESSORIES

ANNEX

A quick reference for fan and accessory part numbers or
order numbers with descriptions.



CONFINED SPACE RESCUE FANS

8"/20CM ELECTRIC BLOWERS - AC

MODEL	PART #	DESCRIPTION
STANDARD AC		
UB20	ED7002	8" 1/3HP Blower-Exhauster - 115V/240v 50/60 Hz Ships as 115V
UB20	ED8002	20cm 1/4HP Blower-Exhauster - 110/240v 50/60 - Stocked as 240v
UB20	ED7015	8" 1/3HP Blower-Exhauster - 115V Incl. Quick-Couple Canister w/15ft duct
UB20	ED8015	20cm 1/4HP Blower-Exhauster - 110/240v Incl. Quick-Couple Can. w/4.6m duct
UB20	ED7025	8" 1/3HP Blower-Exhauster - 115V Incl. Quick-Couple Canister w/25ft duct
UB20	ED8025	20cm 1/4HP Blower-Exhster - 110/240v-Ships 240v-Incl. Quick-Couple Can. w/7.6m duct
STANDARD AC KITS		
UB20 M.E.D.	ED7015-MED	UB20 Manhole Entry System - 115V powered blower
	System includes: (or may be individually ordered)	
	ED7002	8" 1/3HP Blower-Exhauster - 115V/240v 50/60 Hz Ships as 115V
	ED7004CL/DS	Quick-Couple Long Canister, 2 pcs (8") duct - (5ft and 15ft) and duct coupler
	MED5100	M-E-D, Manhole Entry Device, Includes: MED Vent, Elbow, Mount (No Blower)
UB20 M.E.D.	ED8015-MED	UB20 Manhole Entry System - 240v powered blower
	System includes: (or may be individually ordered)	
	ED8002	20cm 1/4HP Blower-Exhauster - 110/240v 50/60 - Stocked as 240v
	ED7004CL/DS	Quick-Couple Long Canister, 2 pcs (8") duct - (5ft and 15ft) and duct coupler
	MED5100	M-E-D, Manhole Entry Device, Includes: MED Vent, Elbow, Mount (No Blower)

12"/30CM ELECTRIC BLOWERS - AC

MODEL	PART #	DESCRIPTION
STANDARD AC		
UB30	EJ4002	12" Blower-Exhauster - 115/240v 50/60HZ Ships 115V with 5-15P
UB30	EJ8002	30cm Blower-Exhauster -110/240V 50/60HZ-Ships 240V SCHUKO

8"/20CM ELECTRIC-STANDARD-DC

MODEL	PART #	DESCRIPTION
STANDARD DC		
UB20-12V	ED9002	8" 1/3HP Blower-Exhauster - Battery Clips (ED-SMHBC15) - 12VDC
UB20-12V	ED9015	8" 1/3HP Blower-Exhauster - Battery Clips - 12VDC Incl. Quick-Couple Canister w/15ft duct
UB20-12V	ED9025	8" 1/3HP Blower-Exhauster -Battery Clips - 12VDC Incl. Quick-Couple Canister w/25ft duct
STANDARD DC KITS		
UB20-12V	ED9015-MED	UB20 Manhole Entry System - 12VDC powered blower
	System includes: (or may be individually ordered)	
	ED9002	8" 1/3HP Blower-Exhauster - Battery Clips (ED-SMHBC15) - 12VDC
	ED7004CL/DS	Quick-Couple Long Canister, 2 pcs (8") duct - (5ft and 15ft) and duct coupler
	MED5100	M-E-D, Manhole Entry Device, Includes: MED Vent, Elbow, Mount (No Blower)
BATTERY PACK SYSTEM		
UB20-12V	ED9002-BAT	UB20 Battery Pack System - 12VDC battery powered blower, battery pack/charger
	System includes: (or may be individually ordered)	
	ED9002	8" 1/3HP Blower-Exhauster - Battery Clips (ED-SMHBC15) - 12VDC
	BPV-12	12V Hi/Lo Battery Pack for use with UB20-12V
UB20-12V	ED9015-BAT	UB20 Battery Pack System - 12VDC battery powered blower, 15ft duct, battery pack/charge

CONFINED SPACE RESCUE FANS

8"/20CM ELECTRIC BLOWERS - DC - BATTERY PACK SYSTEM

MODEL	PART #	DESCRIPTION
System includes: (or may be individually ordered)		
UB20-12V	ED9015	8" 1/3HP Blower-Exhauster - Battery Clips - 12VDC Incl. Quick-Couple Canister w/15ft duct
	BPV-12	12V Hi/Lo Battery Pack for use with UB20-12V
UB20-12V	ED9015-BATCE	UB20 Battery Pack System - 12VDC battery powered blower, 4.6m duct, battery pack/charge
System includes: (or may be individually ordered)		
	ED9015	8" 1/3HP Blower-Exhauster - Battery Clips - 12VDC Incl. Quick-Couple Canister w/15ft duct
	BPV-12CE	12V Hi/Lo Battery Pack for use with UB20-12V CE version with Schuko plug
UB20-12V	ED9025-BAT	UB20 Battery Pack System - 12VDC battery powered blower, 25ft duct, battery pack/charger
System includes: (or may be individually ordered)		
	ED9025	8" 1/3HP Blower-Exhauster -Battery Clips - 12VDC Incl. Quick-Couple Canister w/25ft duct
	BPV-12	12V Hi/Lo Battery Pack for use with UB20-12V
UB20-12V	ED9025-BATCE	UB20 Battery Pack System - 12VDC battery powered blower, 7.6m duct, battery pack/charger
System includes: (or may be individually ordered)		
	ED9025	8" 1/3HP Blower-Exhauster -Battery Clips - 12VDC Incl. Quick-Couple Canister w/25ft duct
	BPV-12CE	12V Hi/Lo Battery Pack for use with UB20-12V CE version with Schuko plug

8"/20CM HAZARDOUS LOCATION ELECTRIC BLOWER - SEE NOTE: 1

MODEL	PART #	DESCRIPTION
SINGLE PHASE ELECTRIC - HAZARDOUS LOCATION BLOWERS EX RATED (II 2 G EX D IIB T6)		
UB20XX	EF7002	8" 1/3HP, 115V, 50/60 IECEX/ATEX/INMETRO Blower-Exhauster, 8" Duct adapters
UB20XX	EF8002	20cm 1/4HP 240v 50/60 Hz IECEX/ATEX/INMETRO Blower-Exhauster, 8" Duct adapters
UB20XX	EF7015	8" 1/3HP XX Blower-Exhaust Incl. Quick-Couple Canister w/15ft anti-static duct
UB20XX	EF8015	20cm 1/4HP Blower-Exhauster Incl. Quick-Couple Canister w/4.6m anti-static duct
UB20XX	EF7025	8" 1/3HP XX Blower-Exhaust Incl. Quick-Couple Canister w/25ft anti-static duct
UB20XX	EF8025	20cm 1/4HP Blower-Exhauster Incl. Quick-Couple Canister w/7.6m anti-static duct
HAZ. LOC. BLOWER KIT		
UB20XX M.E.D.	EF7015-MEDXX	UB20XX Manhole Entry System - 115V powered blower
System includes: (or may be individually ordered)		
	EF7002	8" 1/3HP, 115V, 50/60 IECEX/ATEX/INMETRO Blower-Exhauster, 8" Duct adapters
	EF7004CL/DS	Quick-Couple Long Canister, 2 pcs (8") conductive duct - 5ft and 15ft and duct coupler
	MED189XX	M-E-D, Manhole Entry Device, MED Vent, Black Conductive
	MED90XX	M-E-D, Manhole Entry Device, 90° Elbow Connector, Black Conductive
	MEDUM	M-E-D, Manhole Entry Device, Universal Mount
UB20XX M.E.D.	EF8015-MEDXX	UB20XX Manhole Entry System - 240V powered blower
System includes: (or may be individually ordered)		
	EF8002	20cm 1/4HP 240v 50/60 Hz IECEX/ATEX/INMETRO Blower-Exhauster, 8" Duct adapters
	EF7004CL/DS	Quick-Couple Long Canister, 2 pcs (8") conductive duct - 5ft and 15ft and duct coupler
	MED5100XX	M-E-D,Manhole Entry Device, Anti-Static, Includes: MED Vent, Elbow, Mount (No Blower)

12"/30CM HAZARDOUS LOCATION ELECTRIC BLOWER - SEE NOTE: 1

MODEL	PART #	DESCRIPTION
SINGLE PHASE ELECTRIC - HAZARDOUS LOCATION BLOWERS EX RATED (II 2 G EX D IIB T6)		
EFi75XX	EB7201XX	12" 3/4HP Haz. Loc. Blower - IECEX/ATEX 115/240V 50/60Hz 115 V - 12" duct adapters-ATX
EFi75XX	EB7201XX-230	30cm 3/4HP 115/240V 50/60 Hz IECEX/ATEX blower- Wired 240V - 30cm duct adapters-AT
EFi75XX	EB7201XX-AFNOR	30cm 3/4HP 115/240V 50/60 Hz ATEX blower- Wired 240V - ZAG Adapters-ATX plug

CONFINED SPACE RESCUE FANS

HEATING SYSTEMS ELECTRIC BLOWER-PROPANE HEATER - SEE ACCESSORIES

MODEL	PART #	DESCRIPTION
UB20	ED7125-HT	UB20 In-Line Heater System For Tent/Shelter Heating
System includes: (or may be individually ordered)		
	ED7002	8" 1/3HP Blower-Exhauster - 115V/240v 50/60 Hz Ships as 115V
	FDT-21624046BR	8" ECKO-flex Reinforced duct, 15ft, w/storage bag
	HA01	55,000 BTU Propane Heater - w/Thermostat - w/Regulator Pt# HA01REG
UB20	HA01-100HT	UB20 In-Line Heater System - Confined Space Heating - 15 ft canister
System includes: (or may be individually ordered)		
	ED7015	8" 1/3HP Blower-Exhauster - 115V Incl. Quick-Couple Canister w/15ft duct
	HA01	55,000 BTU Propane Heater - w/Thermostat - w/Regulator Pt# HA01REG
UB20	HA01-125HT	UB20 In-Line Heater System - Confined Space Heating - 25 ft canister
System includes: (or may be individually ordered)		
	ED7025	8" 1/3HP Blower-Exhauster - 115V Incl. Quick-Couple Canister w/25ft duct
	HA01	55,000 BTU Propane Heater - w/Thermostat - w/Regulator Pt #HA01REG
HEATER ONLY		
	HA01	55,000 BTU Propane Heater - w/Thermostat - w/Regulator Pt #HA01REG

FIREFIGHTING FANS

BATTERY - MULTIPURPOSE BLOWER

MODEL	PART #	DESCRIPTION
BATTERY BLOWER AC/DC 40V		
EX50Li	EL5500	AC-DC Vari-Speed Blower, 85-260 VAC, 40 VDC, 18 inch, Plug 5-15P, Carry Strap, NO BATTERY
EX50Li	EL5500-1PK	EL5500 (115v) with 1 R2-360-AH-U Battery & Carrying strap
EX50Li	EL552301PK	EL5500-230 (230v) with 1 R2-360-AH-U Battery & Carrying strap
EX50Li	EL5500-230	AC-DC Vari-Speed Blower, 85-260 VAC, 40 VDC, 46cm, CE, Schuko, Carry Strap, NO BATTERY
EX50Li	EL5500-2PK	EL5500 (115v) with 2 each R2-360-AH-U Batteries & Carrying strap
EX50Li	EL-552302PK	EL5500-230 (240v) with 2 each R2-360-AH-U Batteries & Carrying strap

BATTERY FAN KITS

EX50Li	EL-55ZAC	EX50Li "Zero Downtime Pkg" w/115v Fan/115VAC Charger/4 x Batts/Truck Mount/Carry Strap
System includes: (or may be individually ordered)		
	EL5500	AC-DC Vari-Speed Blower, 85-260 VAC, 40 VDC, 18 inch, Plug 5-15P, Carry Strap, NO BATTERY
	EL600K	Truck compartment mount and tiedowns for EX50Li
	EL6013	Shoulder strap for EX50Li
	R2-360-AH-U	4 each Battery Pack, 40v 6Ah for EX50Li
	R2C-5500AC	Dual Battery Charger, Li-Ion, 40V 3A, 115/240VAC, 5-15P
EX50Li	EL-55ZDC	EX50Li "Zero Downtime Pkg" w/115v Fan/12-24 VDC Charger/4 x Batts/Truck Mount/Carry Strap
System includes: (or may be individually ordered)		
	EL5500	AC-DC Vari-Speed Blower, 85-260 VAC, 40 VDC, 18 inch, Plug 5-15P, Carry Strap, NO BATTERY
	EL600K	Truck compartment mount and tiedowns for EX50Li
	EL6013	Shoulder strap for EX50Li
	R2-360-AH-U	4 each Battery Pack, 40v 6Ah for EX50Li
	R2C-5500DC	Dual Battery Charger, Li-Ion, 40V 1A, Dual Voltage (12 or 24 VDC)
EX50Li	EL-55230ZAC	EX50Li "Zero Downtime Pkg" w/240v Fan/240VAC Charger/4xBatts/Truck Mount/Carry Strap
System includes: (or may be individually ordered)		
	EL5500-230	AC-DC Vari-Speed Blower, 85-260 VAC, 40 VDC, 46cm, CE, Schuko, Carry Strap, NO BATTERY
	EL600K	Truck compartment mount and tiedowns for EX50Li
	EL6013	Shoulder strap for EX50Li

FIREFIGHTING FANS

BATTERY - MULTIPURPOSE BLOWER - BATTERY FAN KITS

MODEL	PART #	DESCRIPTION
	R2-360-AH-U	4 each Battery Pack, 40v 6Ah for EX50Li
	R2C-5500AC230	Dual Battery Charger, Li-Ion, 40V 3A, 115/240VAC, Schuko, CE
EX50Li	EL-55230ZDC	EX50Li "Zero Downtime Pkg" w/240v Fan, 12-24VDC Charger/4xBatts/Truck Mount/CarryStrap
System includes: (or may be individually ordered)		
	EL5500-230	AC-DC Vari-Speed Blower, 85-260 VAC, 40 VDC, 46cm, CE, Schuko, Carry Strap, NO BATTERY
	EL600K	Truck compartment mount and tiedowns for EX50Li
	EL6013	Shoulder strap for EX50Li
	R2-360-AH-U	4 each Battery Pack, 40v 6Ah for EX50Li
	R2C-5500DC	Dual Battery Charger, Li-Ion, 40V 1A, Dual Voltage (12 or 24 VDC)

BATTERY FAN ACCESSORIES

Accessory	R2-360-AH-U	Battery Pack, 40v 6Ah for EX50Li
Accessory	R2C-5500AC	Dual Battery Charger, Li-Ion, 40V 3A, 115/240VAC, 5-15P
Accessory	R2C-5500AC230	Dual Battery Charger, Li-Ion, 40V 3A, 115/240VAC, Schuko, CE
Accessory	R2C-5500DC	Dual Battery Charger, Li-Ion, 40V 1A, Dual Voltage (12 or 24 VDC)
Accessory	EL2211	18" to 16" Duct Adapter for 18" Powershroud blowers, EX50Li
Accessory	EL600K	Truck compartment mount and tiedowns for EX50Li
Accessory	EL6013	Shoulder strap for EX50Li
Accessory	EL7095K	Smoke Ejector Supplemental Kit for EX50Li
Accessory	EL8095K	Hanger Kit for EX50Li, NO DOOR BAR
Accessory	EL8111	Rehab Supplemental Kit for EX50Li, Factory Installed Option
Accessory	EL2211K	Confined Space Rescue Supplemental Kit for EX50Li
System includes: (or may be individually ordered)		
	EL2211	18" to 16" Duct Adapter for 18" Powershroud blowers, for EX50Li
	FDT-1615BR	16"/40cm Reinforced duct, 15'/4.6m
Accessory	EL-ZAC230-CK	Completion Kit for Zero Downtime Package, 230VAC Charger/2 Batts/TruckMount
System includes: (or may be individually ordered)		
	EL600K	Truck compartment mount and tiedowns for EX50Li
	R2-360-AH-U	2 each Battery Pack, 40v 6Ah for EX50Li
	R2C-5500AC	Dual Battery Charger, Li-Ion, 40V 3A, 115/240VAC, 5-15P
Accessory	EL-ZDC-CK	Completion Kit for Zero Downtime Package, 12-24VDC Charger/2 Batts/TruckMount
System includes: (or may be individually ordered)		
	EL600K	Truck compartment mount and tiedowns for EX50Li
	R2-360-AH-U	2 each Battery Pack, 40v 6Ah for EX50Li
	R2C-5500DC	Dual Battery Charger, Li-Ion, 40V 1A, Dual Voltage (12 or 24 VDC)

POSITIVE PRESSURE VENTILATION

MODEL	PART #	DESCRIPTION
ELECTRIC - TURBOFORCE™		
EF390H	EA5403	2.2HP 40cm PPV Ventilator - 240v 50Hz, Single Phase
EV400	EB80500	1.5HP Variable Speed Turbo Blower, 115V, 15A/20A, 16 inch, Plug EZ-L5-20P
EV420	EB81505	1.5HP Variable Speed Turbo Blower, CE, 240V, 50/60Hz, 40 cm-Schuko
EV420	EB80510	1.5HP Variable Speed Turbo Blower, 240V, 50/60Hz, 16 inch, Plug EZ-L6-20P
ELECTRIC - POWERSTREAM®		
EX400	EB80600	1.5HP Vari-Speed Blower w/PowerShroud 115V, 15A/20A, 16 inch, Plug EZ-L5-20P
EX420	EB88245	1.5HP Vari-Speed Blower w/PowerShroud 240V, 50/60Hz, 40 cm CE-Schuko

FIREFIGHTING FANS

POSITIVE PRESSURE VENTILATION

MODEL	PART #	DESCRIPTION
EX500	EK86500	1.5HP Vari-Speed Powershroud Blower, 115V, 15A/20A, 18 inch, Plug EZ-L5-20P
EX520	EK86520	1.5HP Vari-Speed Blower w/PowerShroud, 240V, 50/60Hz, 46cm CE, Schuko

ELECTRIC - SINGLE SPEED - POWERSTREAM® HAZARDOUS LOCATION

XP400	EB80500X	1.5HP Haz. Loc. PPV Blower 115/240v, 50/60Hz, 16 inch, Wired 115v-Plug 5-15P
XP420	EB80500X-230	1.5HP Haz. Loc. PPV Blower 115/240v, 50/60Hz, 40cm, Wired 240v SCHUKO
XP500	EB90600X	1.5HP Haz. Loc. PPV Blower 115/240v, 50/60Hz, PowerShroud-18", Wired 115V, No Plug
XP520	EB90600X-230	1.5HP Haz. Loc. PPV Blower 115/240v, 50/60Hz, PowerShroud-45cm, Wired 240v-SCHUKO

GASOLINE POWERED - TURBOFORCE™

GF164SE	GB5001HSE	16"/40cm Ventilator w/Honda GC160
GF165	GA5006	16"/40cm Ventilator w/Honda GX160 with Oil Alert
GF210	GE5001	21"/54cm Ventilator w/Honda GX160 with Oil Alert

GASOLINE POWERED - POWERSTREAM®

GX200	GG5010	16"/40cm Ventilator w/Honda GXH50
GX200L	GG5500	16"/40cm Ventilator w/Honda GXH50-Ultralightweight PPV
GX310	GH5010	18"/46cm Ventilator w/Honda GX160/4.8hp
GX350	GH5005	18"/46cm Ventilator w/Honda GX200/5.5hp
GX400	GE5022	21"/54cm Ventilator w/Honda GX200
GX400	GE5010	21"/54cm Ventilator w/Vanguard 6.5hp

WATER POWERED

WF390	WB5001LB	Water-powered Ventilator - 1.5" BSP inlet/outlet
WF390	WB5001LNH	Water-powered Ventilator - 1.5" NST/NH inlet
WF540	WD5010	WF540 Water-powered Ventilator - with 1.5" BSP Inlet, 2.5" Outlet

LARGE STRUCTURE VENTILATION

MODEL	PART #	DESCRIPTION
-------	--------	-------------

GASOLINE POWERED - PREMIUM LINE

GX500	GD5005	24" Ventilator w/Honda GX270 8.5HP
GX600	GJ5005	28" Ventilator w/Vanguard V-Twin 18 HP w/ Hourmeter

GASOLINE POWERED - MOBILE PLATFORM

VX700	GK5000	28" Ventilator w/Honda GX630 - Skid Mount Unit only
VX700	GK5005	28" Ventilator w/Honda GX630 - Custom Trailer Mount USA
VX700	GK5010	70 cm Ventilator w/Honda GX630 - CE trailer - Available from EU

16" ELECTRIC SMOKE EJECTORS

MODEL	PART #	DESCRIPTION
-------	--------	-------------

SAFE - HEAT-RESISTANT LEXAN® HOUSING - TEAO MOTORS - SINGLE PHASE

EFC50	EA7000	16" 1/2HP Smoke Ejector - 115/240v-Specify - 15A NEMA 5-15P plug , No switch-No duct adapt
EFC50	EA7000-230	40cm 1/2HP Smoke Ejector - 240v - 16A Schuko plug, No switch, No duct adapters
EFC120	EA7300	40cm 1.2HP Smoke Ejector - 240v- 16" Adapters included,16A Schuko
EFC150	EG8000	16" 1.5HP High Capacity Smoke Ejector - Select 115V or 240v - No duct adapters, 15A NEMA 5

SAFER - HAZARDOUS LOCATION MOTORS RATED FOR CLASS I, GROUP D, CLASS II, GROUP E, F, G

EFC50X	EA7000X	16"/40cm 1/2HP Haz. Loc. Smoke Ejector - 115/240v-Specify - No plug, No duct adapters
EFC50X	EA7000X-230	40cm 1/2HP Smoke Ejector - 240V - No plug, No duct adapters

FIREFIGHTING FANS

16" ELECTRIC SMOKE EJECTORS

MODEL	PART #	DESCRIPTION
EFC120X	EA7300X	40cm 1.2HP Smoke Ejector with HazLoc Motor - 240v- 40cm Adapters included, Schuko
EFC150X	EG8000X	16"/40cm 1.5HP High Capacity Smoke Ejector - Haz. Loc. - Select 115V or 240v - No plug

SAFEST - HAZARDOUS LOCATION, ANTI-STATIC HOUSING - SEE NOTE: 1

Hazardous Location Motors rated for Class I, Group D, Class II, Group E, F, G

EFi50XX	EA8000XX	16" 1/2HP Haz. Loc. Blower - Select 115V or 240v - 16" Adapters included-NO PLUG
EFi50XX	EA8000XX-230	40cm 1/2HP Haz.Loc. Blower - Select 115V or 240v - 40cm Adapters included

Single Phase Electric - Hazardous Location Blowers EX rated (II 2 G Ex de IIB T6 Gb)

EFi120XX	EA8120XX	40cm 1.2HP Haz. Loc. Blower - IECEX/ATEX 110/240V 50Hz only -Wired 240V - 16A ATX plug
EFi120XX	EA8120XX-110	40cm 1.2HP Haz. Loc. Blower - IECEX/ATEX 110/240V 50Hz only -Wired 110V - 16A ATX plug
EFi150XX	EG8200XX	16" 1.5HP 115/240V 50/60 Hz IECEX/ATEX blower- Wired 115V - duct adapters, ATX plug
EFi150XX	EG8200XX-230	40cm 1.5HP 115/240V 50/60 Hz IECEX/ATEX blower- Wired 240V - duct adapters, ATX plug

TILT BRACKET

Accessory	EA9145	40cm Box Fan Tilt Bracket - Fits all 16" EFC/EFi blowers
-----------	--------	--

ACCESSORIES

DUCTING

MODEL	PART #	DESCRIPTION
-------	--------	-------------

STANDARD DUCT W/ STORAGE BAG

Duct	FDT-21624046BR	8"/20cm ECKO-flex Reinforced duct, 15'/4.6m
Duct	FDT-21624076BR	8"/20cm ECKO-flex Reinforced duct, 25'/7.6m
Duct	FDT-30534005BB	12"/30cm ECKO-flex Reinforced duct, 5m
Duct	FDT-30534010BB	12"/30cm ECKO-flex Reinforced duct, 10m
Duct	FDT-1615BR	16"/40cm Reinforced duct, 15'/4.6m
Duct	FDT-1625BR	16"/40cm Reinforced duct, 25'/7.6m

ANTI-STATIC DUCT W/ STORAGE BAG

Duct	FDT-0815CBB	8"/20cm Conductive Reinforced duct, 15'/4.6m
Duct	FDT-0825CBB	8"/20cm Conductive Reinforced duct, 25'/7.6m
Duct	FDT-1215CBB	12"/30cm Conductive Reinforced duct, 15'/4.6m
Duct	FDT-1225CBB	12"/30cm Conductive Reinforced duct, 25'/7.6m
Duct	FDT-1615CBR	16"/40cm Conductive Reinforced duct, 15'/4.6m
Duct	FDT-1625CBR	16"/40cm Conductive Reinforced duct, 25'/7.6m

DISPOSABLE DUCT

Duct	FDT-12DISP	12"/30cm Disposable Layflat polyethylene duct (4mil).....PRICE/100 FEET
Duct	FDT-16DISP	16"/40cm Disposable Layflat polyethylene duct (4mil).....PRICE/100 FEET

LAYFLAT DUCT

Duct	FDT-1625SME	16"/40cm Unreinforced Layflat duct, 25'/7.6m
Duct	FDT-L4X10SME	16"/40cm 90° Unreinforced duct, 4ft x 10ft

REPLACEMENT DUCT FOR UB20 QUICK-COUPLE CANISTER

Duct	FDT-0805CB	8"/20cm Reinforced duct, 5ft (replacement only)
Duct	FDT-0815CR	8"/20cm Reinforced duct, 15'/4.6m (replacement only)
Duct	FDT-0825CR	8"/20cm Reinforced duct, 25'/7.6m (replacement only)

REPLACEMENT DUCT FOR UB20XX QUICK-COUPLE CANISTER

Duct	FDT-0805CCB	8"/20cm Conductive Reinforced duct, 5ft/1.5m (replacement only)
Duct	FDT-0815CRX	8"/20cm Conductive Reinforced duct, 15'/4.6m (replacement only)
Duct	FDT-0825CRX	8"/20cm Conductive Reinforced duct, 25'/7.6m (replacement only)

ACCESSORIES

DUCTING

MODEL	PART #	DESCRIPTION
-------	--------	-------------

DUCT ACCESSORIES

Accessory	BG8	8"/20cm Duct Carrying Bag
Accessory	BG12	12"/30cm Duct Carrying Bag
Accessory	BG16	16"/40cm Duct Carrying Bag
Accessory	DC8	8"/20cm Duct Coupler Stainless HD
Accessory	DC12	12"/30cm Duct Coupler Stainless HD
Accessory	DC16	16"/40cm Duct Coupler Stainless HD
Accessory	EA7116	16" ABS Duct Adapter for "Box Fans" INLET/EXHAUST except for EX-rated
Accessory	EA7117	16" ABS Duct Adapter for "Box Fans" EX-rated exhaust fans only
Accessory	EC0301	8"/20cm Duct Adapter/Reducer for the 12"/30cm UB30
Accessory	GH2211	18" to 16" Duct Adapter for 18" Powershroud blowers, GX350,EX500
Accessory	EL2211	18" to 16" Duct Adapter for 18" Powershroud blowers, for EX50Li

HEATER ACCESSORIES

Accessory	HA01T1	Heater Thermostat control with 25'/7.6m of cable, Included with HA01
Accessory	HAT25EXT	Heater Thermostat Extension 25'/7.6m Works with HA01T1

M.E.D. SYSTEM ACCESSORIES

Accessory	MED189	M-E-D, Manhole Entry Device, MED Vent
Accessory	MED189XX	M-E-D, Manhole Entry Device, MED Vent, Black Conductive
Accessory	MED5100	M-E-D, Manhole Entry Device, Includes: MED Vent, Elbow, Mount (No Blower)
Accessory	MED5100XX	M-E-D, Manhole Entry Device, Anti-Static, Includes: MED Vent, Elbow, Mount (No Blower)
Accessory	MED90	M-E-D, Manhole Entry Device, 90° Elbow Connector
Accessory	MED90XX	M-E-D, Manhole Entry Device, 90° Elbow Connector, Black Conductive
Accessory	MEDUM	M-E-D, Manhole Entry Device, Universal Mount

MISTING AND REHABILITATION COMPONENTS

Accessory	EB8111	EV400/420 and EX400/420 Integrated Mister Option
Accessory	GH8112	GX350/EX500 PC/ABS Shroud integrated Mister Option (Factory Install)
Accessory	GH8112-FLD	GX350/EX500 PC/ABS Shroud integrated Mister Option (Field Install)
Accessory	GE8111	GX400 Integrated Mister Option
Accessory	GD8111	GX500 Integrated Mister Option
Accessory	GD8111M	GX500 Integrated Mister Option-BSP
Accessory	GJ8111	GX600 Integrated Mister Option
Accessory	EL8111	EX50Li Integrated Mister Option (Factory Installed)
Accessory	ED-MIST16	16" Cooling Collar for RAMFAN 16" Blowers (May require duct adapter-CALL)

PPV - ACCESSORIES

Accessory	GA400K	16"/40 cm PowerStream® Upgrade Kit for GF, EF, EV, and WF Series
Accessory	GE400K	21"/54 cm PowerStream® Upgrade Kit for GF and WF Series
Accessory	GX1515	Honda GX160/200/270 Hour meter Option (Factory Install only)
Accessory	GF7115	Exhaust Diverter Hose Assembly (2" dia x 12ft) (All Models) w/ Bag
Accessory	GF7110-CZ	Honda Engine Model GC160 Exhaust Diverter Add-on DIN std. (No hose)
Accessory	GF7110-DZ	Honda Engine Model GX120 Exhaust Diverter Add-on DIN std. (No hose)
Accessory	GF7110-KZ	Honda Engine Model GXH50 Exhaust Diverter Add-on DIN std. (No hose)
Accessory	GF7110-LZ	Honda GX270 Exhaust Diverter Muffler/Connector/Hose Assembly
Accessory	GF7120-BZ	Honda Engine Model GX160 Exhaust Diverter Add-on DIN std. (No hose)
Accessory	GF7120-GZ	Honda Engine Model GX200 Exhaust Diverter Add-on DIN std. (No hose)
Accessory	GH2211	18" to 16" Duct Adapter for 18" Powershroud blowers, GX350, EX500

ACCESSORIES

PPV - ACCESSORIES

MODEL	PART #	DESCRIPTION
Accessory	BG16LFA	16"/40cm Multi-Purpose Accessory Pack
System includes: (or may be individually ordered)		
	BG16LF	Storage bag for Layflat Duct, 90° duct and Mist-16 Kit
	ED-MIST16	16" Cooling Collar for RAMFAN 16" Blowers (May require duct adapter-CALL)
	FDT-1625SME	16"/40cm Unreinforced Layflat duct, 25'/7.6m
	FDT-L4X10SME	16"/40cm 90° Unreinforced duct, 4ft x 10ft

SMOKE EJECTOR ACCESSORIES

Accessory	EA7081	Door Bar - EF series 50(X)/120(X)/150(X) and EX50Li
Accessory	EA7092K	Hanger Kit - EF series 50(X)/120(X)/150(X)
Accessory	EA7095K	Hanger Kit w/Door Bar- EF series 50(X)/120(X)/150(X)

UB20 ACCESSORIES

Accessory	BPV-12	12V Hi/Lo Battery Pack for use with UB20-12V
Accessory	BPV-12CE	12V Hi/Lo Battery Pack for use with UB20-12V CE version with Schuko plug
Accessory	ED0304	Inlet duct adapter for UB20
Accessory	ED7004CL	Quick-Couple Canister with 25'/7.6m of 8"/20cm reinforced duct for UB20
Accessory	ED7004CL/DS	Quick-Couple Long Canister, 2 pcs (8"/20cm) duct - (5'/1.5m and 15'/4.6m) and duct coupler
Accessory	ED7004CS	Quick-Couple Canister with 15'/4.6m of 8"/20cm reinforced duct for UB20
Accessory	ED7300	UB20 High Pressure Turbo-Coupler
Accessory	ED-SMH5	Cord Connector- Battery Pack to DC Blower (5ft cable & SMH plugs)
Accessory	ED-SMHBC15	Battery Pack (ED-BP612) plug to Battery Clip Adapter
Accessory	EF7004CL	Quick-Couple canister with 25./7.6m of 8"/20cm Conductive reinforced duct for UB20XX
Accessory	EF7004CL/DS	QC Long Canister, 2 pcs (8"/20cm) conductive duct - 5'/1.5m and 15'/4.6m & duct coupler
Accessory	EF7004CS	Quick-Couple Canister with 15'/4.6m of 8"/20cm Conductive reinforced duct for UB20XX

PLUGS

Accessory	EZ-5-15P	115V Plug - NEMA 5-15P (15 amp)
Accessory	EZ-ATX96433	IECEX/ATEX-Appleton (PRE316PB) 16A/240V Plug-Standard
Accessory	EZ-ATX96433-S	IECEX/ATEX-STAHl (8570/12-306) 16A/240V Plug
Accessory	EZ-L5-15P	115V Plug - NEMA L5-15P (15 amp Twist-Lok)
Accessory	EZ-L5-20P	115V Plug - NEMA L5-20P (20 amp Twist-Lok)
Accessory	EZ-L5-30P	115V Plug - NEMA L5-30P (30 amp Twist-Lok)
Accessory	EZ-L6-20P	240v Plug - NEMA L6-20P (20 amp Twist-Lok)

Notes:

- (1) Units are built with EN60309.1 plugs, unless noted. The US/Canadian market lacks a standardized plug configuration for "EX-PROOF" use. Please request plug options at time of order.
- (2) Specify thread: 1.5" NST, NPSH, BSP or special.



There is a lot riding on the smooth functioning of your equipment - your own safety and the welfare of others. That is why Euramco Safety provides fast and comprehensive service as a standard operational procedure.

All products offered by Euramco Group are designed and manufactured with care. If you are unfamiliar with a product, you and your team should learn how to use it properly before putting it into operation. Our experts offer special training sessions for all devices.

You should study the user manual in depth prior to start-up. If in doubt, please contact your specialist dealer. Fire-fighting and rescue equipment is placed under great strain in actual practice. Carry out maintenance on a regular basis in order to ensure that it always functions smoothly.

Please contact your specialist dealer or one of our partners if a device is malfunctioning. They will provide a speedy repair service.

STARTUP

Please read the instruction manual carefully before start-up. You should familiarize yourself, and your team of users, with your product in detail before using it for the first time. We will provide certifications of compliance and other certificates on request.

All goods sold by Euramco Safety are manufactured in accordance with ISO 9001.

MAINTENANCE & REPAIRS

Please refer to the operating manual for information on the maintenance of your products sold by Euramco Safety. Should you have any questions, please contact your specialist dealer.

Please contact our sales staff if a product requires servicing or repair. We will accept products in need of servicing or repair. We will accept products in need of servicing, discuss the quickest and cheapest solution with you, prepare cost estimates, carry out the work and answer questions you may have. Please send us return shipments with the Euramco Return Material Authorization Form.

If necessary, we will send you a specialist to carry out repairs on-site. Needless to say, the service technician will bring spare parts and other materials with him, you need not worry about a thing.

Some larger items will require special service considerations. Please contact the repair and service center for repair and maintenance work. Our team will ascertain whether the work needs to be done on-site or in our service center and will be happy to answer any further questions you may have.

TRAINING & PRESENTATIONS

You should be able to use and operate your equipment with ease. That is why we give you ample opportunity to put our products through their paces before purchasing them. Qualified experts will consult with you on-site with regard to your requirements and specifications. They will show you how the actual appliance works and what it can do. Only then will you make an informed decision.

Special training programs give you and your team an opportunity to familiarize in detail with your new equipment. Our trainers will explain correct handling and carry out practical exercises.

Euramco Safety has teamed up with China's premier firefighting media company, China Fire Bulletin, to help provide comprehensive training guides for technical firefighting and rescue equipment. Make sure your fire department is subscribed to receive their quarterly print magazine to keep your team up to date on techniques, tactics and equipment.



Go to www.ramfan.com to find everything you need:

- Product Information
- Online Catalog
- Latest Industry News
- Certifications
- FAQ
- Warranty Information
- Technical Bulletin
- Manuals

Distributed by:



USA
2746 Via Orange Way
Spring Valley, CA 91978 USA
Toll Free: (800) 472-6326
Phone: +1 (619) 670-9590
Fax: +1 (619) 670-7345
theteam@euramco.com

LUXEMBOURG
1 Rue Edmond Reuter,
5326 Contern, Luxembourg
Phone: +352-621377200
Fax: +352-26008056
theteam@euramco.com

MIDDLE EAST – UAE
Jebel Ali FTZ, Dubai
Phone: +1 (619) 670-9590 x114
Fax: +1 (619) 670-7345
theteam@euramco.com

CHINA
A11, No. 1 Jinxi Road
Qingshuipu, Zhenhai, Zhejiang
Ningbo, China 315221
Phone: +86-574-87979390
Fax: +86-574-87979391
saleschina@euramco.com